

TIMER INSTRUCTIONS

PRODUCT DESCRIPTION

Transmitters with timer functions in the UHF bandwidth with a pll carrier frequency. Allows the possibility of programming 6 daily commands each week and the possibility of having automatic commands linked to dawn and dusk in the chosen country. They are best used for the remote activation of electrical and electronic devices controlling door, sunblind, awning and shutter openers in respect with the local standards and regulations in force. The system uses "rolling code" in order to make duplication impossible and to guarantee maximum secrecy. The transmitted code can either be inserted directly into the receiver or sent via radio. This second possibility allows you insert transmitters into existing installations without having to physically access the receiver. This operation can be carried out by the end user and doesn't require the presence of the installer.

PARTICULARS FUNCTION

ASTRO 1: (Sunblind) When you insert this function the timer will automatically carry out an opening and closing command every day according to the dawn and dusk times.
ASTRO 2: (Light) When you insert this function the timer will automatically carry out an opening and closing command every day according to the dusk and dawn times.
WEEK: Weekly programming allows you to send automatic radio signals.
RANDOM: This function enables a presence simulation.
AUTO: The AUTO function is needed to enable the automatic functions.
CH: The CH function allows you to invert the radio commands ch1 with ch2 and ch3 with ch4.

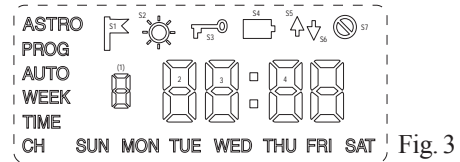

3. SYMBOLS LIST

- S2: Lights up when the passage from summertime to wintertime is in automatic mode.
- S3: Lights up when buttons 1,2,3 and 4 are locked (see button locking function).
- S4: Lights up when the battery is about to discharge.
- S5,S6: They light up individually after a radio signal is sent by buttons 1,2,3,4 or in pairs during the remote memorization stage by pressing button 6.
- S7: Lights up when the random function is enabled or during the programming stage.

SAFETY STANDARDS

- Do not store or activate the manual transmitter in damp, steamy, highly humid, dusty places or places exposed to direct sunlight or similar conditions.
- Keep the manual transmitter in a stable condition; dropping it could cause damage or a reduction in its range of action.

INTERFERENCE

- The device is in no way protected from interference by other appliances or telecommunications installations (for example, authorised radio devices working on the same frequency wavelength).
- If you experience transmission range problems, position the manual transmitter in a different location and if necessary replace the battery.

REPLACING THE BATTERY

- 1) Open the cover.
- 2) Remove the batteries and replace them with new ones in the same way. **Make sure the polarity is correct (+/-)!**

- Store the batteries away from children. If batteries should be ingested call a doctor immediately.
- Incorrect battery replacement could cause irreparable damage to the appliance.
- Only use type CR 2032 to replace the batteries.



- Always wrap the batteries both when they are being stored as well as when they are being eliminated. The battery must not come into contact with other metal objects; this could discharge, burn or damage the batteries.

Do not dispense with the batteries in household rubbish bins.

EUROPEAN UNION CONFORMITY DECLARATION

The transmitter conforms to the essential requirements and regulations of the directive R&TTE 1999/ 5/EC. A copy of the conformity declaration is available from the web site at www.telecoautomation.com/ce.

The applied standards and directives:

- European directives regarding electromagnetic compatibility 89/336/CEE• EN 300220-1, EN 300683, EN 60950

ELECTRICAL CHARACTERISTICS

The transmitters are encoded by the manufacturer with individual codes different from each other.

Attention!! If you keep a transmitter button pressed down for more than 30 seconds it will switch off automatically.

Power supply	3V. (lithium battery CR2032)
Power consumption at rest	2nA
Power consumption when transmitting	8mA
Carrier frequency	868.3MHz
Modulation	FSK
Operating temperature range	from 0° to 50 °C

PUSH-BUTTON FUNCTION IN MENU MODE

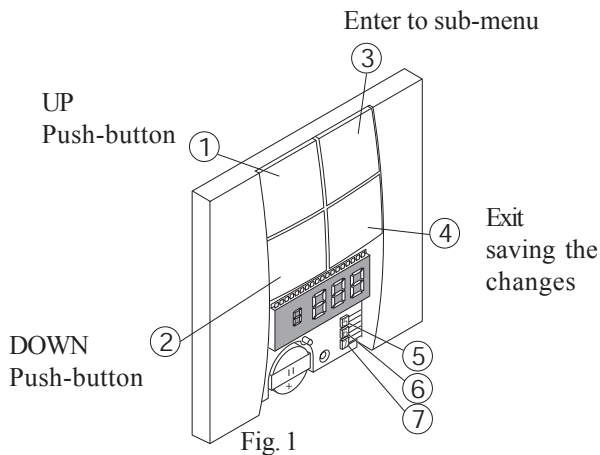

PUSH-BUTTON FUNCTION IN TIMER MODE

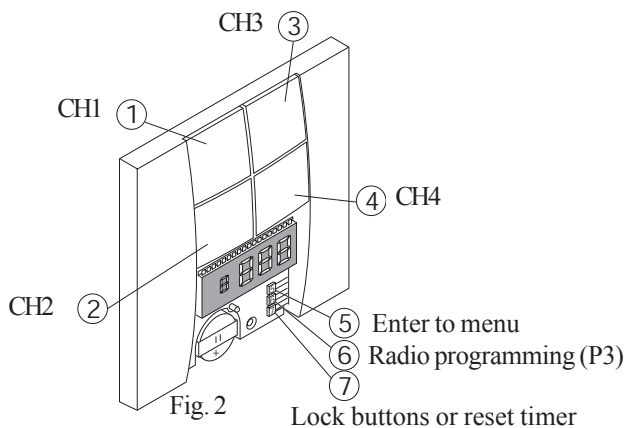

Attention: If, after 60 seconds, no buttons have been pressed the device will move back to the timer mode, saving the changes.

Code Number:	Series	Model number	Draft	Date
TVTXC868C04	TVLink RS868		T140.02	06-05-06

SETTING THE DATE AND TIME TIME FUNCTION

- Press and hold down button 5 for 3 seconds.
- The word Menü apperas at the display.

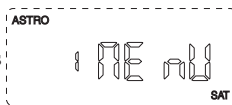

- Scroll the menu using button 1 or 2 until the indication TIME appears.



- Press button 3 to enter the sub-menu.

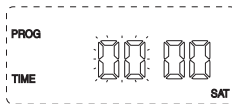

- Set the hour using buttons 1 or 2.
- Confirm with button 3.

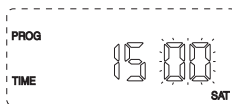

- Set the minutes using buttons 1 or 2.
- Confirm with button 3.

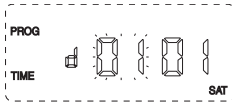

- Set the day using buttons 1 or 2.
- Confirm with button 3.

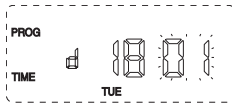

- Set the month using buttons 1 or 2.
- Confirm with button 3.



- Set the year using buttons 1 or 2.
- Confirm with button 3.

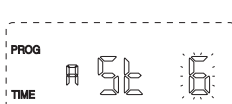

- Set the geographical zone using buttons 1 or 2. (see ASTRO table)
- Confirm with button 3.

- Press button 4 to exit from sub-menü TIME saving the changes, press again to exit from Menü.
The seconds are reset automatically when you exit from sub-menü TIME.

- Using buttons 1 or 2 choose the command (max 6 per day)
- Confirm with button 3.

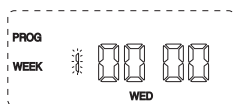

- Set the hour using buttons 1 or 2.
- Confirm with button 3.

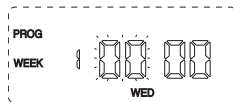

- Set the minutes using buttons 1 or 2.
- Confirm with button 3.

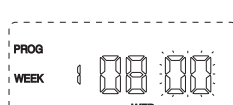

- Select the command you wish to send by pressing buttons 1 or 2. To not send any commands set "00".

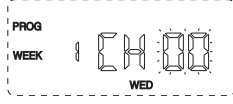

- Press button 4 to exit from sub-menü WEEK saving the changes, press again to exit from Menü.

Attention!

- For this function to work you must activate the AUTO function.

Attention!

- You may only send one command for each time, if you set two commands for the same time they will not be carried out correctly.

Attention!

- To copy one commad in every day of week:

- Enter on week programmig and choose the command (Ex. "3").

- Press button 6.

- Symbols of day flashing two times.

- Command "3" was copied on every day of week.

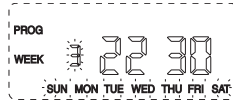
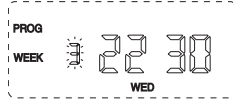

AUTO FUNCTION

- The AUTO is needed to enable the automatic functions RANDOM, ASTRO and WEEK. If it isn't activated the functions will not work.

- Press and hold down button 5 for 3 seconds.
- The word Menü apperas at the display.

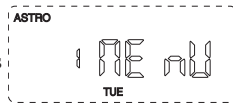

- Scroll the menu using button 1 or 2 until the indication AUTO appears.



- Press button 3 to enter the sub-menu.

- Using the buttons 1 or 2 to activate or deactivate the function.

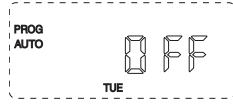

- Press button 4 to exit from sub-menü AUTO saving the changes, press again to exit from Menü.

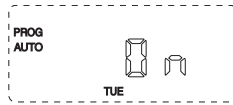

- If you have activated this function the simbol AUTO will be lighted.

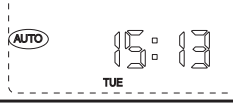

INVERTING RADIO COMMANDS CH FUNCTION

The CH function allows you to invert the radio commands ch1 with ch2 and ch3 with ch4.
ex.

after inversion
button 1 = ch1 →→→ button 1 = ch2
button 2 = ch2 →→→ button 2 = ch1

- Press and hold down button 5 for 3 seconds.
- The word Menü apperas at the display.

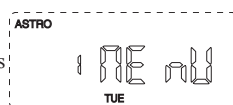

- Scroll the menu using button 1 or 2 until the indication CH appears.
- Press button 3 to enter the sub-menu.

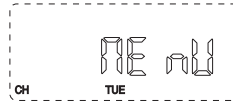

- Using the buttons 1 or 2 to activate or deactivate the function.

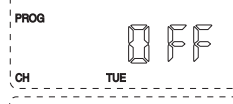

- Press button 4 to exit from sub-menü saving the changes, press again to exit from Menü.

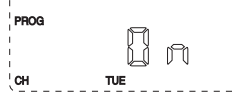

- If you have activated this function the simbol ASTRO will be lighted.

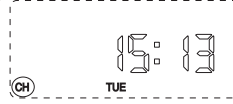

Attention!

- This inversion automatically modifies the settings in the WEEK program.

LOCK BUTTONS

- This function allow to lock 1, 2, 3 and 4 buttons.

- From timer menu, press button 7 for lock and press again for unlock.

- If you have activated this function the simbol  will be lighted.

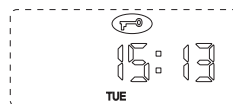

WEEKLY PROGRAMMING WEEK FUNCTION

Weekly programming allows you to send automatic radio signals (up to 6 for each day of the week).

- Press and hold down button 5 for 3 seconds.
- The word Menü apperas at the display.

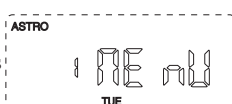

- Scroll the menu using button 1 or 2 until the indication WEEK appears.



- Press button 3 to enter the sub-menu.

- Choose the day you wish to program using buttons 1 or 2.
- Confirm with button 3.

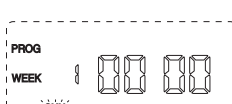

RESET TIMER

- For reset all settings press and hold down button 7 for 5 seconds.

- During the reset the word reset flashing on the display.

ASTRO TABLE

There are nine tables according to the geographical zone. They can be listed and selected by inserting the time zone number in the sub-menu TIME:

zone 0: Fixed time (dawn always at 8:00AM; dusk: jun. jul. aug. at 22:00PM; jan. feb. mar. apr. may. sept. oct. nov. dec. at 20:00PM)

zone 1: Scandinavia

zone 2: Great Britain

zone 3: Northern Germany, Denmark

zone 4: Northern France, Benelux

zone 5: Southern Germany

zone 6: Southern France

zone 7: Northern Italy, Switzerland, Austria

zone 8: Spain

zone 9: Southern Italy, Sicily, Sardinia, Corsica

PRESENCE SIMULATION RANDOM FUNCTION

- Presence simulation. If you insert the RANDOM function the time of the programmed radio signals is varied casually in intervals of ±15 minutes from the set time.

- Press and hold down button 5 for 3 seconds.
- The word Menü appears at the display.

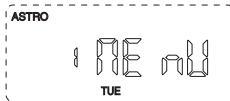

- Scroll the menu using button 1 or 2 until the indication  appears.
- Press button 3 to enter the sub-menu.

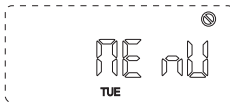

- Using the buttons 1 or 2 to activate or deactivate the function.

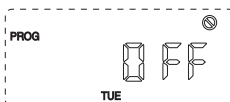

- Press button 4 to exit from sub-menu saving the changes, press again to exit from Menü.

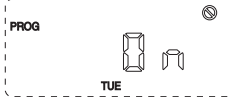

- If you have activated this function the symbol  will be lighted.

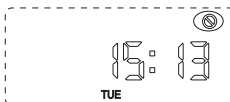

AUTOMATIC ADJUSTMENT FOR PASSAGE FROM SUMMERTIME TO WINTERTIME

- Activating this function, the last Sunday of March and the last Sunday of October, the timer adjust automatically the time.

- Press and hold down button 5 for 3 seconds.
- The word Menü appears at the display.

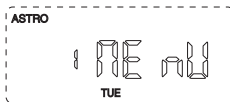

- Scroll the menu using button 1 or 2 until the indication  appears.
- Press button 3 to enter the sub-menu.

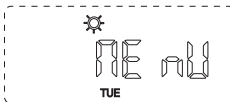

- Using the buttons 1 or 2 to activate or deactivate the function.

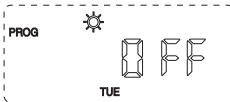

- Press button 4 to exit from sub-menu saving the changes, press again to exit from Menü.

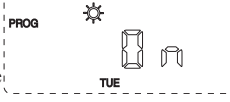

- If you have activated this function the symbol  will be lighted.

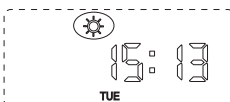

ASTRO1 FUNCTION (ASTRO SUNBLIND)

- When you insert this function the timer will automatically carry out an opening and closing command every day according to **the dawn (opening) and dusk (closing)** times in the chosen country.

If (with the ASTRO function inserted) you have programmed commands in the WEEK menu linked to channels 1 and 2 they will be automatically modified as follows:

The ch1 opening command programmed for the various days of the week is compared to the opening time in the ASTRO table and the later one is chosen. While the closing time in the ASTRO table (dusk) is always chosen for the closing command ch2.

This function only works with channels 1 and 2.

- Press and hold down button 5 for 3 seconds.

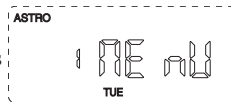

- The word Menü appears at the display.

- Scroll the menu using button 1 or 2 until the indication ASTRO1 appears.



- Press button 3 to enter the sub-menu.

- Using the buttons 1 or 2 to activate or deactivate the function.

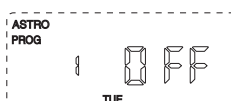

- Press button 4 to exit from sub-menu saving the changes, press again to exit from Menü.

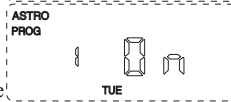

- If you have activated this function the symbol ASTRO1 will be lighted.

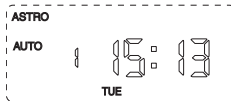

Attention!

- For this function to work you must activate the AUTO function.

Attention!

- You may only active one function ASTRO at the same time, when you actived one function the other is automatically deactivated.

ASTRO2 FUNCTION (ASTRO LIGHT)

- When you insert this function the timer will automatically carry out an opening and closing command every day according to **the dusk (opening) and dawn (closing)** times in the chosen country.

If (with the ASTRO function inserted) you have programmed commands in the WEEK menu linked to channels 1 and 2 they will be automatically modified as follows:

The opening time in the ASTRO table (dusk) is always chosen for the opening command ch1. While the ch2 closing command programmed for the various days of the week is compared to the closing time in the ASTRO table (dawn) and the first after the dusk is chosen.

This function only works with channels 1 and 2.

- Press and hold down button 5 for 3 seconds.

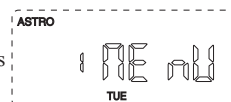

- The word Menü appears at the display.

- Scroll the menu using button 1 or 2 until the indication ASTRO2 appears.

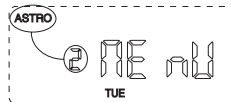

- Press button 3 to enter the sub-menu.

- Using the buttons 1 or 2 to activate or deactivate the function.

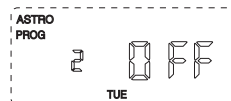

- Press button 4 to exit from sub-menu saving the changes, press again to exit from Menü.

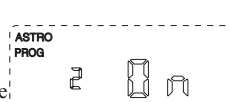

- If you have activated this function the symbol ASTRO2 will be lighted.

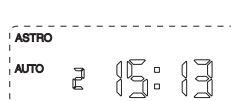

Attention!

- For this function to work you must activate the AUTO function.

Attention!

- You may only active one function ASTRO at the same time, when you actived one function the other is automatically deactivated.

Attention: Because of the variation of the dusk time in the space of a year, it could be possible that the closing time (programmed on WEEK) would be lower than the activation time given from the dusk. In this case the closing time will be changed automatically after the dusk time. To calculate the new time of deactivation you have to add to the dusk time the difference between the summer dusk and the winter dusk.

$$\text{Time deactivation} = \text{Time}_{\text{today dusk}} + (\text{Time}_{\text{summer dusk}} - \text{Time}_{\text{winter dusk}})$$

-ASTRO function examples

TIME	WEEK (set command)	ASTRO	FUNCTION CARRIED OUT
1) 6:00 6:31	ch1	DAWN ch1	none none (Opening will occur at a later time)
2) 10:00	ch1		ch1 (there are no later times so ch1 is sent)
3) 14:00	ch2		none (closing occurs at dusk)
4) 17:00	ch3		ch3 (ASTRO does not effect ch3)
5) 18:00	ch4		ch4 (ASTRO does not effect ch4)
19:15		DUSK ch2	ch2 (closing)
6) 20:00	ch2		none (already closed at dusk)

DIMENSIONS

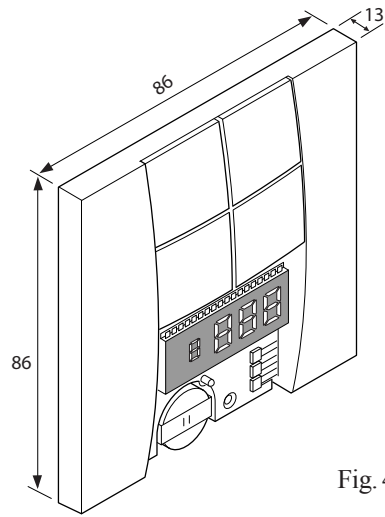

Fig. 4

ASSEMBLING

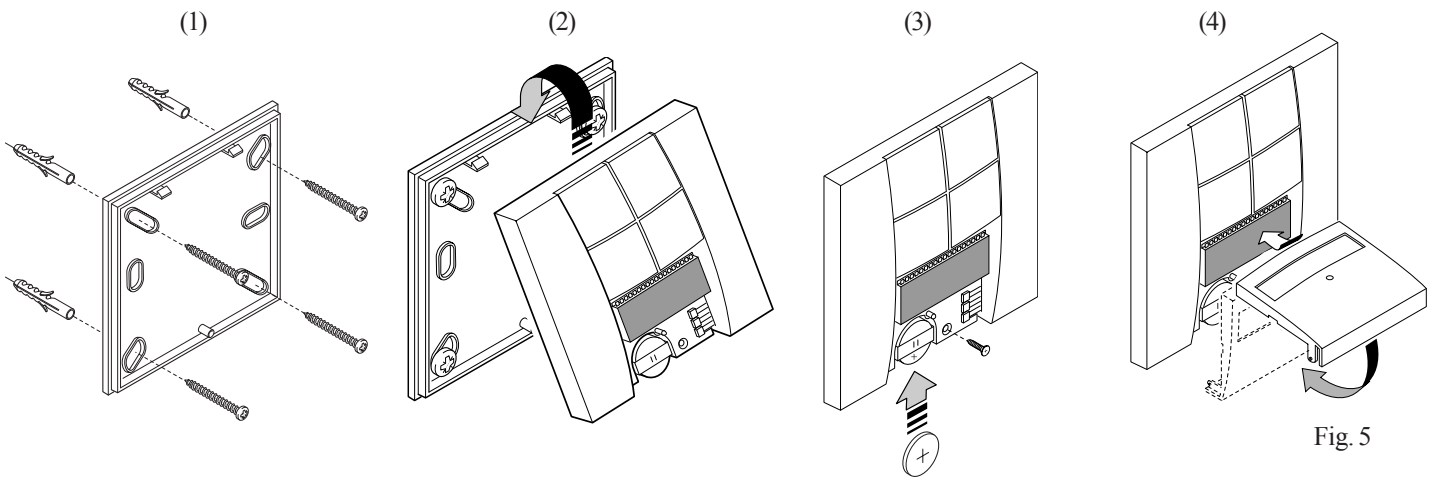

Fig. 5